



KERN & Sohn GmbH

Ziegelei 1
72336 Balingen-Frommern
Germany

www.kern-sohn.com

+0049-[0]7433-9933-0

+0049-[0]7433-9933-149

info@kern-sohn.com

Operating instruction Precision balance

KERN PCJ

Type TPCJ-A

Version 1.1

2024-07

GB



TPCJ-BA-e-2411



KERN PCJ

Version 1.1 2024-07

Operating instructions Precision balance

Content

1	Technical data.....	5
2	Declaration of conformity	6
3	Appliance overview	7
3.1	Components.....	7
3.2	Operating instruments	8
3.2.1	Keyboard overview.....	8
3.2.2	Numeric entry.....	9
3.2.3	Overview of display	9
4	Basic Information (General)	10
4.1	Proper use.....	10
4.2	Improper Use.....	10
4.3	Warranty.....	10
4.4	Monitoring of Test Resources.....	11
5	Basic Safety Precautions	11
5.1	Pay attention to the instructions in the Operation Manual	11
5.2	Personnel training.....	11
6	Transport and storage.....	11
6.1	Testing upon acceptance	11
6.2	Packaging / return transport	11
7	Unpacking, Installation and Commissioning.....	12
7.1	Installation Site, Location of Use	12
7.2	Unpacking and checking	13
7.3	Assembling, Installation and Levelling.....	13
7.4	Mains connection.....	13
7.5	Battery operation (optional)	15
7.6	Rechargeable battery operation (optional)	16
7.6.1	Load rechargeable battery	16
7.7	Connection of peripheral devices	17
7.8	Initial Commissioning.....	17

7.9	Adjustment	17
7.9.1	Internal calibration <CAL INT>	18
7.9.2	Define calibration interval <CAL INT DEF>.....	19
7.9.3	GLP compliant calibration protocol <CAL GLP>.....	21
8	Calibration.....	23
9	Basic Operation	25
9.1	Turn on/off	25
9.2	Simple Weighing.....	25
9.3	Zeroing	27
9.4	Taring	27
9.5	Change-Button (default setting).....	28
9.5.1	Switch-over weighing unit.....	29
9.5.2	Display gross weight value.....	30
9.6	Underfloor weighing.....	31
10	Operating concept	32
11	Application <Weighing >	34
11.1	Application-specific settings	34
11.2	PRE-Tare	35
11.2.1	Taking over the placed weight as the PRE-TARE value.....	35
11.2.2	Entering the known tare in the numerical form	36
11.3	Data-hold function	36
11.4	Unit.....	37
11.4.1	Switch-over weighing unit.....	37
11.4.2	Weighing with the multiplication factor <FFA>	38
11.4.3	Percentage weighing <%>	38
12	Application <Counting>.....	39
12.1	Settings specific for the application	39
12.2	Apply application	40
12.2.1	Check counting	43
13	Application < Checkweighing >.....	46
13.1	Settings specific for the application	46
13.2	Apply application	47
13.2.1	Target weighing.....	47
13.2.2	Checkweighing.....	50
14	Menu.....	52
14.1	Menu navigation.....	52
14.2	Application menu.....	52

14.3	Setup-menu.....	53
14.3.1	Overview < ኔፎፎፎፎ >	53
15	Communication with a peripheral device using KUP	58
15.1	KERN Communications Protocol	59
15.2	KERN alibi memory	60
15.3	Data transfer functions	61
15.3.1	Summing mode < ኔፎፎ >	61
15.3.2	Data transfer after pressing the PRINT < ጠጠጠጠጠጠ > button.....	63
15.3.3	Automatic data transfer < ጠፎፎፎ >.....	64
15.3.4	Continuous data transfer < ርፎፎፎ >.....	64
15.4	Data format	65
16	Maintenance, service and disposal.....	66
16.1	Cleaning	66
16.2	Maintenance and service	66
16.3	Disposal	66
17	Help for any minor failures	67
18	Error messages	68

1 Technical data

KERN	PCJ 6000-1M	PCJ 600-2M
Item no./ Type	TPCJ 6000-1M-A	TPCJ 600-2M-A
Readability (d)	0,1 g	0,01 g
Weighing range (max)	6000 g	600 g
Taring range (subtractive)	6000 g	600 g
Reproducibility	0,1 g	0,01 g
Linearity	± 0,3 g	± 0,03 g
Stabilization time (typical)	3 s	
Verification value (e)	1 g	0,1 g
Verification class	II	II
Minimum weight (min)	5 g	0,5 g
Smallest part weight for piece counting - under lab conditions*	200 mg	20 mg
Smallest part weight for piece counting - under normal conditions**	2 g	200 mg
Recommended adjustment weight (not supplied)	internal	
Warm-up time	2 h	
Weighing Units	kg, g, ct	
Humidity of air	max. 80% rel. (non-condensing)	
Allowable ambient temperature	-10 °C ... + 40 °C	
Input voltage Appliance	5.9 V, 1 A	
Input voltage Mains adapter	100 V - 240V AC 50 / 60Hz	
Batteries (option)	4 x 1,5V AA	
Rechargeable battery operation (optional)	Operating period 48 h (background illumination OFF) Operating period 24 h (background illumination ON) Loading time approx. 8 hrs.	
Auto-Off (battery, rechargeable battery)	selectable off, 30s, 1, 2, 5, 30, 60 min	
Dimensions housing (W x D x H) [mm]	163x245x80 (B x T x H) [mm]	
Weighing pan	150 x 170 (B x T) [mm]	130 x 130 (B x T) [mm]
Net weight (kg)	2,7	2,0
Interfaces	RS-232 (optional), Ethernet (optional), Bluetooth BLE (v4.0) (optional), USB-Device (optional), WiFi (optional) via KUP	
Underfloor weighing device	yes (hook supplied)	

*** Smallest component weight for part counting - under lab conditions:**

- There are ideal ambient conditions for high-resolution counting
- The parts to be counted are not scattered

**** Smallest component part for part counting – under normal conditions:**

- There are unsteady ambient conditions (draft, vibrations)
- The parts to be counted are being scattered

2 Declaration of conformity

The current EC/EU Conformity declaration can be found online in:

www.kern-sohn.com/ce

3 Appliance overview

3.1 Components





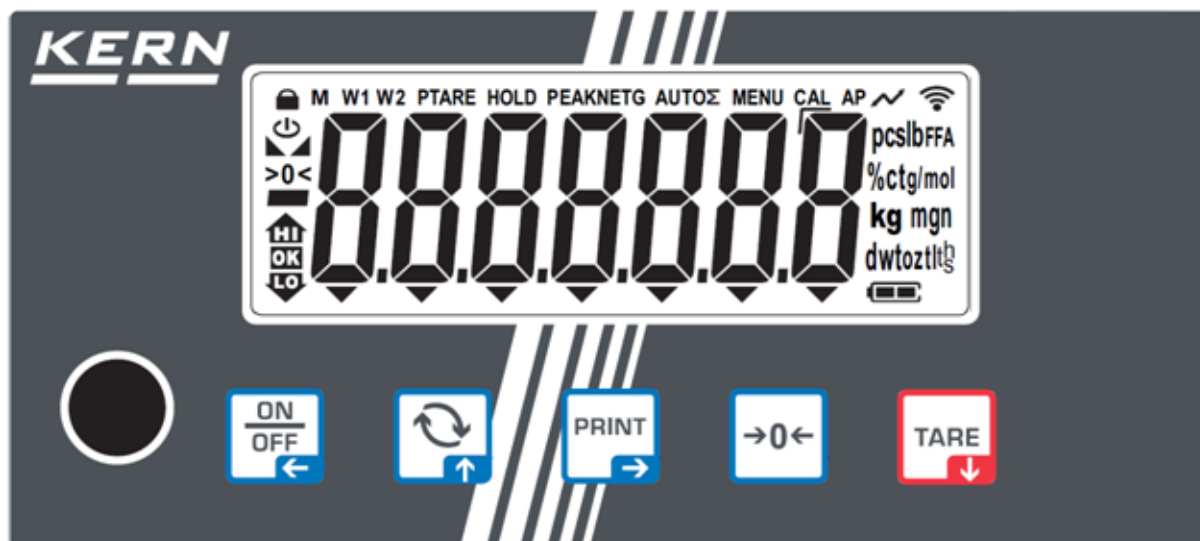

Pos.	Description	Pos.	Description
1	Weighing pan	7	KUP connection (KERN Universal Port)
2	Display	8	Calibration knob
3	Keyboard	9	Battery compartment
4	Bubble level	10	Footscrews
5	Connection anti-theft device (Kensington lock)	11	Underfloor weighing device
6	Mains adapter connection	12	Transport lock (position depends on model)



3.2 Operating instruments



3.2.1 Keyboard overview





Button	Name	Function in Operating mode	Function in Menu
	ON/OFF- Button	<ul style="list-style-type: none"> ➤ Turn on/off (long button press) ➤ Background illumination of the display on/off (short button press) 	<ul style="list-style-type: none"> ➤ Navigation key ← ➤ Menu level back ➤ Exit menu / back to weighing mode
	TARE- Button	<ul style="list-style-type: none"> ➤ Taring 	<ul style="list-style-type: none"> ➤ Invoke application menu (press button long time) ➤ Navigation key ↓ ➤ Select menu item
	ZERO- Button	<ul style="list-style-type: none"> ➤ Zeroing (Zeroing range 2% maximum) 	
	↻-Button	<ul style="list-style-type: none"> ➤ Quick change button, see chap. 9.5 	<ul style="list-style-type: none"> ➤ Navigation key ↑ ➤ Select menu item
	PRINT- Button	<ul style="list-style-type: none"> ➤ Transmit weighing data via interface 	<ul style="list-style-type: none"> ➤ Navigation key → ➤ Activate menu item ➤ Confirm selection

3.2.2 Numeric entry

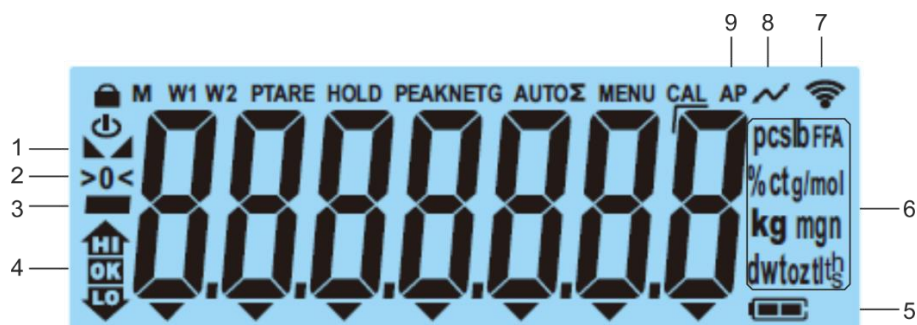
Taste	Bezeichnung	Funktion
	Navigation key →	Select cipher Confirm entry. Press button repeatedly for every digit. Wait until the numeric input window extinguishes.
	Navigation key ↓	Reduce flashing cipher (0 – 9)
	Navigation key ↑	Increase flashing cipher (0 – 9)

3.2.3 Overview of display



Position	Display	Description
1		Stability display
2	>0<	Zero display
3	—	Minus display
4		Tolerance marks for check weighing
5		Rechargeable battery charge indicator
6	Einheitenanzeige / Pcs/ %	options g, kg, ct or Application icon [Pcs] for piece counting or [%] for determination of percentage
7		WIFI-symbol
8		Data transfer running
9	AP	Autoprint enabled
-	G	Display gross weight value
-	NET	Display net weight value
-	Σ	Weighing data can be found in the sum memory

4 Basic Information (General)

4.1 Proper use

The balance you purchased is intended to determine the weighing value of material to be weighed. It is intended to be used as a “non-automatic balance”, i.e. the material to be weighed is manually and carefully placed in the centre of the weighing pan. As soon as a stable weighing value is reached, the weighing value can be read.

4.2 Improper Use

Our balances are non-automatic balances and not provided for use in dynamic weighing processes. However, the balances can also be used for dynamic weighing processes after verifying their individual operative range, and here especially the accuracy requirements of the application.

Do not leave permanent load on the weighing pan. This may damage the measuring system.

Impacts and overloading exceeding the stated maximum load (max) of the balance, minus a possibly existing tare load, must be strictly avoided. Balance may be damaged by this.

Never operate the balance in explosive environment. The serial version is not explosion protected.

The structure of the balance may not be modified. This may lead to incorrect weighing results, safety-related faults and destruction of the balance.

The balance may only be used according to the described conditions. Other areas of use must be released by KERN in writing.

4.3 Warranty

Warranty claims shall be voided in case:

- Our conditions in the operation manual are ignored
- The appliance is used beyond the described uses
- The appliance is modified or opened
- Mechanical damage and damage by media, liquids, natural wear and tear
- The appliance is improperly set up or incorrectly electrically connected
- The measuring system is overloaded

4.4 Monitoring of Test Resources

In the framework of quality assurance the measuring-related properties of the balance and, if applicable, the testing weight, must be checked regularly. The responsible user must define a suitable interval as well as type and scope of this test. Information is available on KERN's home page (www.kern-sohn.com) regarding the monitoring of balance test substances and the test weights required for this. In KERN's accredited DKD calibration laboratory test weights and balances may be calibrated (return to the national standard) fast and at moderate cost.

5 Basic Safety Precautions

5.1 Pay attention to the instructions in the Operation Manual



⇒ Carefully read this operation manual before setup and commissioning, even if you are already familiar with KERN balances.

5.2 Personnel training

The appliance may only be operated and maintained by trained staff.

6 Transport and storage

6.1 Testing upon acceptance

When receiving the appliance, please check packaging immediately, and the appliance itself when unpacking for possible visible damage.

6.2 Packaging / return transport



- ⇒ Keep all parts of the original packaging for a possibly required return.
- ⇒ Only use original packaging for returning.
- ⇒ Prior to dispatch disconnect all cables and remove loose/mobile parts.
- ⇒ Reattach possibly supplied transport securing devices.
- ⇒ Secure all parts such as the wind screen, the weighing platform, power unit etc. against shifting and damage.

7 Unpacking, Installation and Commissioning

7.1 Installation Site, Location of Use

The balances are designed in a way that reliable weighing results are achieved in common conditions of use.

You will work accurately and fast if you select the right location for your balance.

Therefore, observe the following for the installation site:

- Place the balance on a firm, level surface.
- Avoid extreme heat as well as temperature fluctuation caused by installing next to a radiator or in the direct sunlight.
- Protect the balance against direct draughts due to open windows and doors.
- Avoid jarring during weighing.
- Protect the balance against high humidity, vapours and dust.
- Do not expose the device to extreme dampness for longer periods of time. Non-permitted condensation (condensation of air humidity on the appliance) may occur if a cold appliance is taken to a considerably warmer environment. In this case, acclimatize the disconnected appliance for ca. 2 hours at room temperature.
- Avoid static charge of goods to be weighed or weighing container.
- Do not operate in areas with hazard of explosive material or in potentially explosive atmospheres due to materials such as gasses, steams, mists or dusts.
- Keep away chemicals (such as liquids or gasses), which could attack and damage the balance inside or from outside.
- Keep IP protection of the device.
- In the event of the occurrence of electromagnetic fields, static charges (e.g., when weighing / counting plastic parts) and unstable power supply, large display deviations (incorrect weighing results, as well as damage to the scale) are possible. In that case, the location must be changed.

7.2 Unpacking and checking

Remove device and accessories from packaging, remove packaging material and install the device at the planned workplace. Check if that there has been no damage and that all items of delivery scope are present.

Scope of delivery / serial accessories:

- Balance, see chap. 3.1
- Mains adapter
- Operating instructions
- Protective cover
- Underfloor weighing hook
- Allen key

7.3 Assembling, Installation and Levelling

⇒ Remove the transport locks on the underside of the scale.

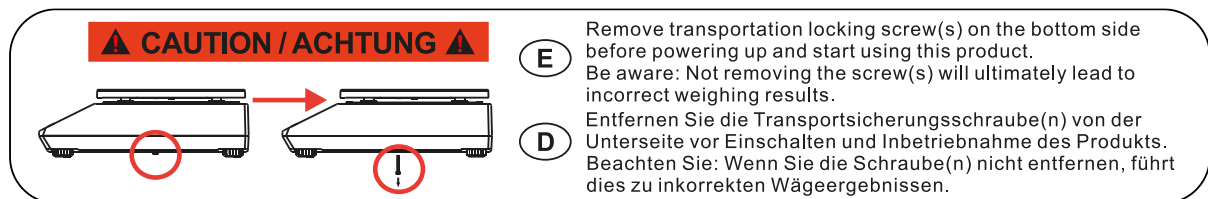

⇒ Install weighing plate and wind shield if necessary.

⇒ Ensure that the balance is installed in a level position.

⇒ Level balance with foot screws until the air bubble of the water balance is in the prescribed circle.

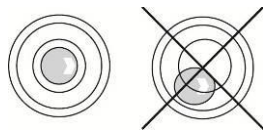

⇒ Check levelling regularly

7.4 Mains connection



Select a country-specific power plug and insert it in the mains adapter.



Check, whether the voltage acceptance on the scales is set correctly. Do not connect the scales to the power mains unless the information on the scales (sticker) matches the local mains voltage.

Only use KERN original mains adapter. Using other makes requires consent by KERN.



Important:

- Before starting your weighing balance, check the mains cable for damage.
- Ensure that the power unit does not come into contact with liquids.
- Ensure access to mains plug at all times.

7.5 Battery operation (optional)

When the batteries are exhausted, in the display will appear <L 0 bAt>.

- ⇒ Rotate the balance carefully in a way that the bottom of the balance is freely accessible.
- ⇒ Open the battery compartment and exchange the batteries.

Ensure correct polarisation.

- ⇒ Close again the lid.



- To save the battery, in menu (see chap. 14.3.1.) the automatic switch-off function <AutoFF> can be activated.
- If the balance is not used for a longer time, take out the battery and store it separately. Leaking battery liquid could damage the balance.

7.6 Rechargeable battery operation (optional)

ATTENTION



- ⇒ The rechargeable battery and the battery match with each other. Only use the delivered mains adapter.
- ⇒ Do not use the balance during the loading process.
- ⇒ The rechargeable can only be replaced by the same or by a type recommended by the manufacturer.
- ⇒ The rechargeable battery is not protected against all environmental influences. If the rechargeable battery is exposed to certain environmental influences, it may set on fire or explode. Persons may be injured or material damage may occur.
- ⇒ Protect the rechargeable battery against fire and heat.
- ⇒ Do not bring the rechargeable battery in contact with fluids, chemical substances or salt.
- ⇒ Do not expose the rechargeable battery to high pressure or micro-waves.
- ⇒ Under no circumstances the rechargeable batteries and the charging unit may be modified or manipulated.
- ⇒ Do not use a defective, damaged or deformed rechargeable battery.
- ⇒ Do not connect or short-circuit the electrical contacts of the rechargeable battery with metallic objects.
- ⇒ Liquid may squirt out from a damaged rechargeable battery. If the liquid gets into contact with the skin or the eyes, the skin and the eyes may be irritated.
- ⇒ Ensure the correct polarity when inserting or changing the rechargeable battery (see instructions in the battery compartment)
- ⇒ The rechargeable battery operation is overridden when the mains adapter is connected. For weighing in mains operation > 48 hrs. the rechargeable batteries must be removed! (Danger of overheating).
- ⇒ If the rechargeable battery starts to smell, being hot, changing the colour or being deformed, it must be immediately unplugged from mains supply and from the balance if possible.

7.6.1 Load rechargeable battery

The rechargeable battery pack (Option) is charged using the mains cable supplied.

Before the first use, the rechargeable battery package should be charged by connecting it to the mains power cable for at least 15 hours.

To save the rechargeable battery, in menu (see chap.14.3.1.) the automatic switch-off function $\langle \text{A} \square \text{FF} \rangle$ can be activated.

If the capacity of the rechargeable batteries is exhausted, $\langle \text{L} \square \text{bAL} \rangle$ appears in the display. Connect the power cable as soon as possible to load the rechargeable battery. Charging time until complete recharging is approx. 8 h.

7.7 Connection of peripheral devices

Before connecting or disconnecting of additional devices (printer, PC) to the data interface, always disconnect the balance from the power supply.

With your balance, only use accessories and peripheral devices by KERN, as they are ideally tuned to your balance.

7.8 Initial Commissioning

In order to obtain exact results with the electronic balances, your balance must have reached the operating temperature (see warming up time chap. 1). During this warming up time the balance must be connected to the power supply (mains, rechargeable accumulator or battery).

The accuracy of the balance depends on the local acceleration of gravity.

Strictly observe hints in chapter Adjustment.

7.9 Adjustment

As the acceleration value due to gravity is not the same at every location on earth, each display unit with connected weighing plate must be coordinated - in compliance with the underlying physical weighing principle - to the existing acceleration due to gravity at its place of location (only if the weighing system has not already been adjusted to the location in the factory). This adjustment process must be carried out for the first commissioning, after each change of location as well as in case of fluctuating environment temperature. To receive accurate measuring values it is also recommended to adjust the display unit periodically in weighing operation.







- i** • Observe stable ambient conditions. A warm-up period (see chap 1) is required for stabilization.
- Make sure that there are no objects on the weighing plate.
- Avoid vibrations and air currents.
- Carry out calibration/adjustment only with the standard weighing plate in place.
- Adjustment is blocked on scales with type approval.

To unlock the access block, the seal mark must be destroyed and the calibration switch must be pressed. For the position of the calibration switch, see section 8.

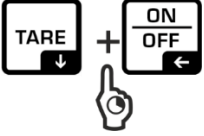





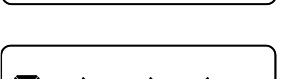
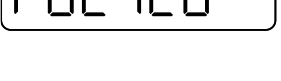
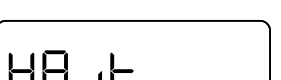
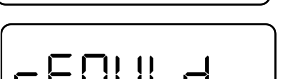
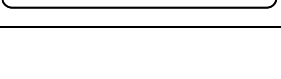

- **Attention:**

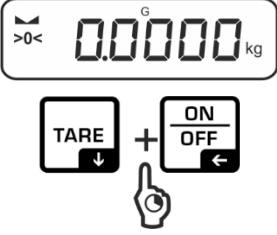
After destruction of the seal, the balance must be recalibrated by an authorized agency and a new seal must be affixed before it may be used again in legal-for-trade applications.





7.9.1 Internal calibration <cAL int>

	<p>⇒ Press and hold the TARE and ON/OFF buttons simultaneously to enter the setup menu.</p>
	
	
	
	<p>⇒ Wait until the first menu item <cAL > is displayed.</p>
	<p>⇒ Confirm by →-button, <cAL int > is displayed.</p>
	
	
	<p>⇒ Confirm by →-button, <cAL int > is displayed alternating with <Put iLd >.</p>
	<p>⇒ Pull out the calibration knob and turn it clockwise until resistance is felt.</p>
	<p>⇒ Wait, till <rENULd > is displayed.</p>
	<p>⇒ Turn the calibration knob counterclockwise until a resistance is felt and press it back into the housing.</p>
	<p>⇒ Scale automatically switches to active mode</p>

7.9.2 Define calibration interval <cALt int>

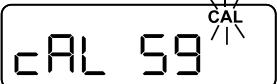
	<p>⇒ Press and hold the TARE and ON/OFF buttons simultaneously to enter the setup menu.</p>
	
	<p>⇒ Wait until the first menu item <cAL > is displayed.</p>
	<p>⇒ Confirm by →-button, <cAL int > is displayed.</p>
	<p>⇒ Use the navigation keys ↓↑ to select <cALt int >.</p>
	<p>⇒ Confirm by →-button.</p>
	<p>⇒ Use the navigation keys ↓↑ to select the calibration interval (1h / 2h / 4h / 8h) and confirm it with the →-button.</p>
	<p>⇒ To exit the menu press ←-button repeatedly.</p>

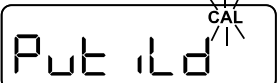
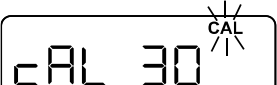
Selected CAL time reached

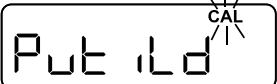
Behavior of the balance when the calibration interval is reached	
	⇒ 5 min before the defined calibration interval is reached, a countdown appears on the display starting at < cAL 59 >
	
	⇒ After the countdown has elapsed, < cAL int > is displayed alternating with < Put ILd >.
	⇒ Pull out the calibration knob and turn it clockwise until resistance is felt.
	⇒ Carry out the internal adjustment as described see chap.7.9.1.
Behavior of the balance when the calibration interval is reached & calibration aborted	
	⇒ There is the option of canceling the internal calibration once. Therefore, confirm with the ←-button during the countdown.
	⇒ Afterwards, 5 min remain to complete the current process. During this time, the CAL symbol (4min) flashes in the display. In the last minute, the CAL symbol lights up permanently.
	⇒ After the 5 min have elapsed, the balance is in a forced calibration mode.
	⇒ The balance requests with < Put ILd > to pull out and turn the calibration knob
	⇒ Carry out the internal adjustment as described see chap. 7.9.1



Internal calibration

The internal calibration must be performed in the following cases:

Each time the balance is switched on and disconnected from the power supply.

Each time the balance is switched on in battery or rechargeable battery mode.

After the adjustment interval has been reached, see chap 7.9.2

7.9.3 GLP compliant calibration protocol <cAL GLP>

⇒ Press and hold the TARE and ON/OFF buttons simultaneously to enter the setup menu.

⇒ Wait until the first menu item <cAL > is displayed.

⇒ Confirm by →-button, <cAL int > is displayed.

⇒ Use the navigation keys ↓↑ to select <cAL GLP >.

⇒ Confirm by →-button.

⇒ To obtain a GLP-compliant calibration protocol, select <ON >. To deactivate, select <OFF >.

⇒ Confirm by →-button.

⇒ To exit the menu press ←-button repeatedly.

Beispielausdruck:

CAL-INTERNAL		Calibration type

TYPE	PCJ 6000-1M	Model
SN	WF23001844	Serial No.
BALID	0175	Balance identification no.
ALIID	0076	Alibi memory identification no.

DATE	2023 Jan 08	Date
TIME	12:45:36	Time

REF =	1000.0 g	Used calibration weight
BFR =	1000.2 g	Before adjustment
AFT =	1000.0 g	After adjustment
-COMPLETE		

-SIGNATURE-		Processor

8 Calibration

General:

According to EU Directive 2014/31EU, weighing instruments must be calibrated if they are used as follows (legally regulated area):

- In commercial transactions, when the price of a good is determined by weighing.
- In the manufacture of medicines in pharmacies and in analyses in medical and pharmaceutical laboratories.
- For official purposes
- In the manufacture of prepackages

In case of doubt, please contact your local calibration office.

Weighing instruments in the legally regulated range (-> calibrated weighing instruments) must comply with the limits of error in use during the period of validity of verification - these are generally twice the limits of error of verification.

If this calibration validity period expires, a recalibration must be performed. If it is necessary to adjust the weighing instrument to comply with the calibration error limits in order to pass this recalibration, this does not constitute a case of warranty.

Calibration instructions:

The weighing instruments marked as legal for trade in the technical data have been issued with an EU type approval. If the scale is used in the legal-for-trade area as described above, it must be calibrated and regularly recalibrated.

The recalibration of a scale is carried out according to the respective legal regulations of the countries. The verification period in Germany, for example, is usually 2 years for weighing instruments.

The legal regulations of the country of use must be observed!

i The calibration of the weighing instrument is invalid without the sealing marks.

For weighing instruments with type approval, the attached seal marks indicate that the weighing instrument may only be opened and serviced by trained and authorized personnel. If the seal marks are destroyed, the calibration validity expires. The national laws and regulations must be observed. In Germany, recalibration is required.

Position of sealing marks:

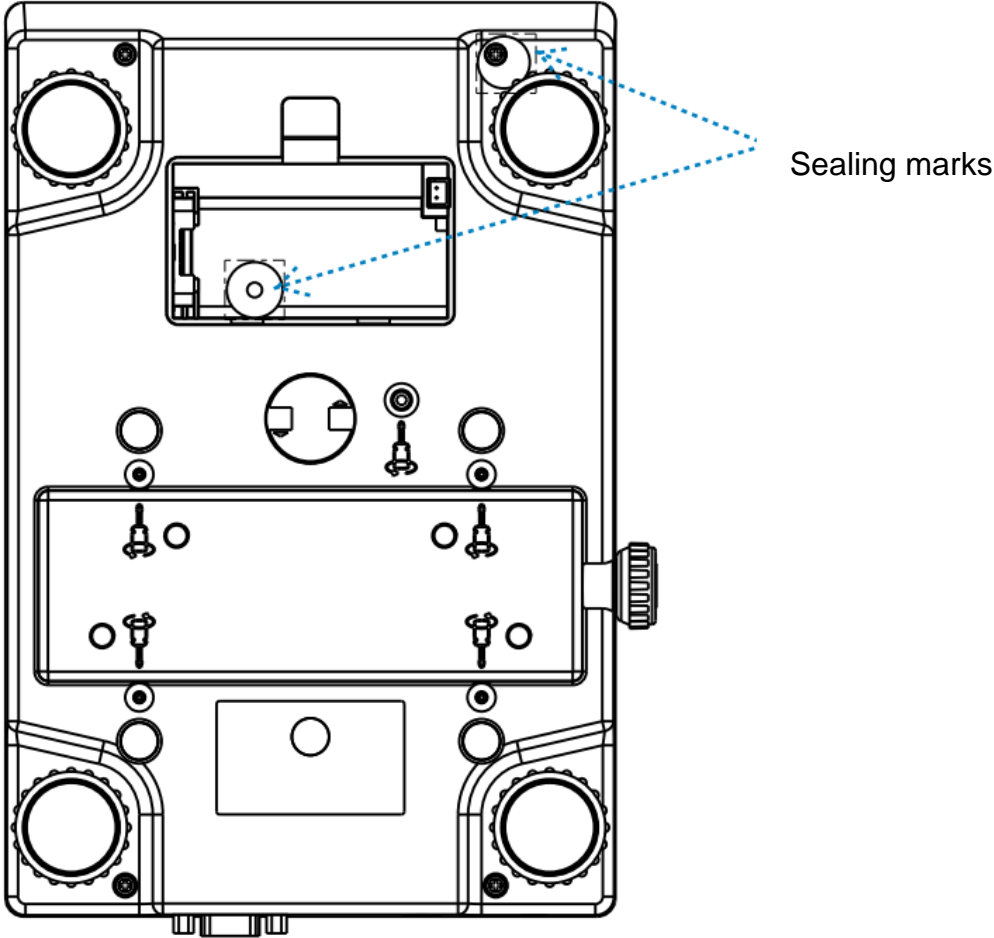

9 Basic Operation

9.1 Turn on/off

Start-up:

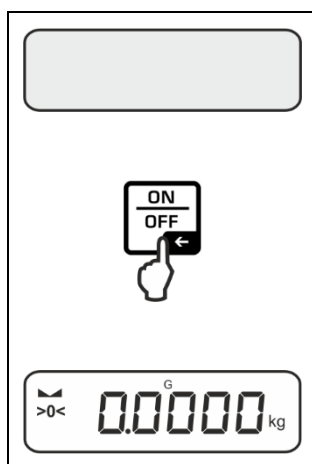

- ⇒ Press the **ON/OFF** button.
The display lights up and the balance carries out a self-test.
- ⇒ If the balance has been disconnected from the mains voltage, an internal calibration must be carried out, see Chap.7.9.1.
- ⇒ Wait until the weight display appears
The scales are now ready to weigh using the last active application



Internal calibration

The internal calibration must be performed in the following cases:

- Each time the balance is switched on and disconnected from the power supply.
- Each time the balance is switched on in battery or rechargeable battery mode.
- After the adjustment interval has been reached, see chap 7.9.2.

Switching off:

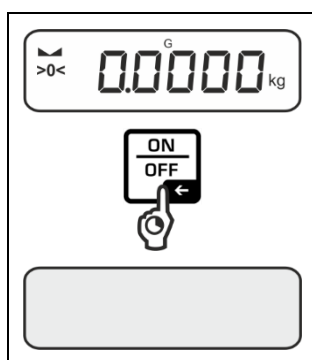

- ⇒ Keep **ON/OFF** button pressed until the display disappears

9.2 Simple Weighing



- ⇒ Check zero display [**>0<**] and set to zero with the help of the **ZERO** key, as required.
- ⇒ Place goods to be weighed on balance
- ⇒ Wait until the stability display appears (▣).
- ⇒ Read weighing result.



Overload warning

Overloading exceeding the stated maximum load (max) of the device, minus a possibly existing tare load, must be strictly avoided.

This could damage the instrument.

Exceeding the maximum load is indicated by the display “ $\overline{\text{---}}$ ”. Unload balance or reduce preload.

9.3 Zeroing

In order to obtain optimal weighing results, reset to zero the balance before weighing. Zeroing is only possible in the range $\pm 2\%$ Max.

For values greater than $\pm 2\%$ maximum the error message $\langle \text{OL} \text{ } \text{HI} \text{ } \text{LE} \rangle$ is displayed

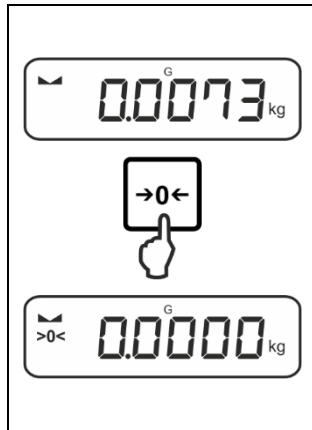

- ⇒ Unload the balance
- ⇒ Press the **ZERO** key to set the balance to zero.



These balances have an automatic zero tracking [<3d], which cannot be switched off.

In the event that small quantities are removed or added to the material to be weighed, incorrect weighing results can be displayed due to the “stability compensation”. (e.g. slow flow of liquids from a container placed on the balance, evaporating processes).

9.4 Taring

The dead weight of any weighing container may be tared away by pressing a button, so that the following weighing procedures show the net weight of the goods to be weighed.

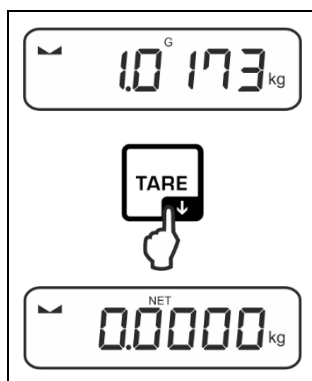

- ⇒ Put weighing container on the weighing pan.
- ⇒ Wait until the stability display appears (▴ ▾), then press **TARE** key. The weight of the container is now internally saved. Zero display and indicator **<NET>** will appear. **<NET>** informs that all shown weight values are net values.



- When the balance is unloaded the saved taring value is displayed with negative sign.
- To delete the stored tare value, unload the weighing plate and press the **TARE** key or the **ZERO** key.
- The taring process can be repeated any number of times, e.g. when adding several components for a mixture (adding). The limit is reached when the taring range capacity is full.

- Numerical input of tare (PRE-TARE)

9.5 Change-Button (default setting)

The Change button  can be assigned with different functions.

The following functions are set as standard (<DEFAULT >) for the various weighing applications:

	short button press	long button press
WE ih	<ul style="list-style-type: none"> ➤ When pressed for the first time: Set weighing unit ➤ Toggle between weighing units 	<ul style="list-style-type: none"> ➤ When the balance has been tared and the weighing unit is displayed, you can change the display between gross weight, net weight and tare weight by pressing the button long time.
count	<ul style="list-style-type: none"> ➤ When pressed for the first time: Set reference quantity ➤ Toggle between weighing units 	<ul style="list-style-type: none"> ➤ When the balance has been tared and the weighing unit is displayed, you can change the display between gross weight, net weight and tare weight by pressing the button long time.
chEcH	<ul style="list-style-type: none"> ➤ When pressed for the first time: Set weighing unit ➤ Toggle between weighing units 	<ul style="list-style-type: none"> ➤ When the balance has been tared and the weighing unit is displayed, you can change the display between gross weight, net weight and tare weight by pressing the button long time.

i Further setting options can be found in the setup menu under <בטע -
טוהב>, see chap. 14.3.1.

The default settings (<DEFAULT >) for the <weighing> application are described below.

9.5.1 Switch-over weighing unit

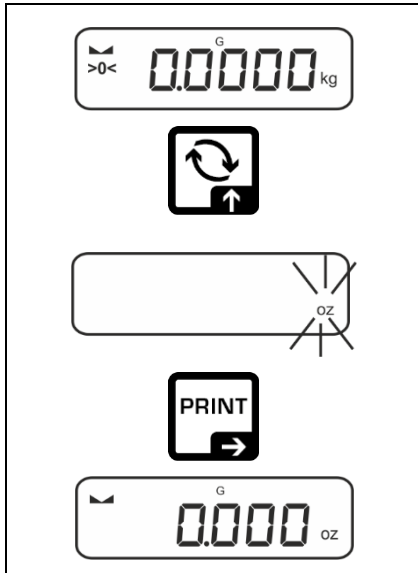

By default, the Change button  is set to switch between the weighing unit by a **short** button press.

Activate units:





When the -button is pressed short for the first time, the unit for the quick selection can be set

⇒ Press -button and wait until the display flashes.

⇒ Use the navigation   keys to select the and confirm with the -button.

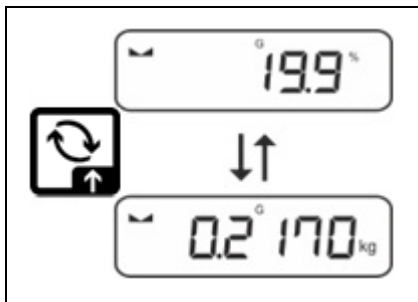
Switching units:



⇒ Use the -button to switch between the active unit 1 and unit 2

Activate another unit:

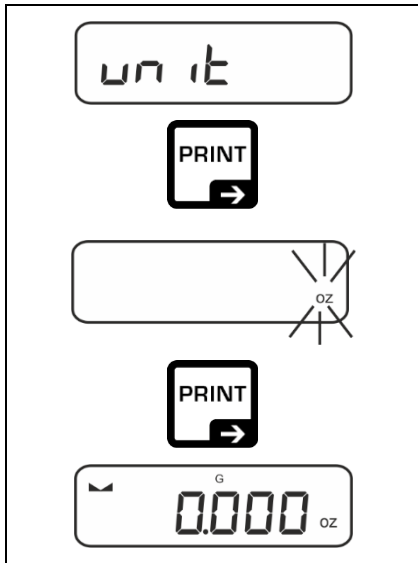

⇒ Select menu setting < unit > and confirm with →-button.

⇒ Wait until the display flashes.

⇒ Select the weighing unit with the navigation keys ↓↑ and confirm with the →-button.

i The required settings when selecting an application unit (% , FFA) can be found in chap. 11.4.2 and 11.4.3.

9.5.2 Display gross weight value

By default, the Change button ↻ is set to display the gross weight value by a **long** button press

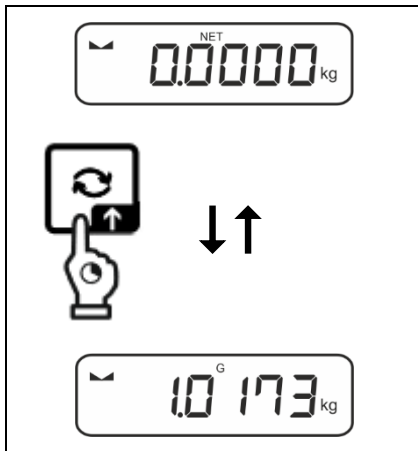

⇒ - Press and hold the ↻-button until the display shows the gross weight value.

After releasing the button, the gross weight value is briefly shown in the display.

9.6 Underfloor weighing

Objects unsuitable for placing on the weighing scale due to size or shape may be weighed with the help of the flush-mounted platform.

Proceed as follows:

- ⇒ Switch off the balance.
- ⇒ Open closing cover at the balance bottom.
- ⇒ Place weighing balance over an opening.
- ⇒ Completely screw-in the hook
- ⇒ Hook-on the material to be weighed and carry out weighing.

CAUTION

- **Always ensure that all suspended objects are stable enough to hold the desired goods to be weighed safely (danger of breaking).**
- **Never suspend loads that exceed the stated maximum load (max) (danger of breaking)**

Always ensure that there are no persons, animals or objects that might be damaged underneath the load.

NOTICE

After completing the underfloor weighing the opening on the bottom of the balance must always be closed (dust protection).

10 Operating concept

From factory the balance is delivered with various applications (normal weighing, check weighing, counting). After the first start-up the balance is in the <Weighing> application.

In the **application menu** (see chap.14.2.) however, you can define, selecting an application, in which mode the balance after switching-on has to continue working. Either as per standard in weighing mode or e.g. as check balance or counting balance.

Selecting an application:

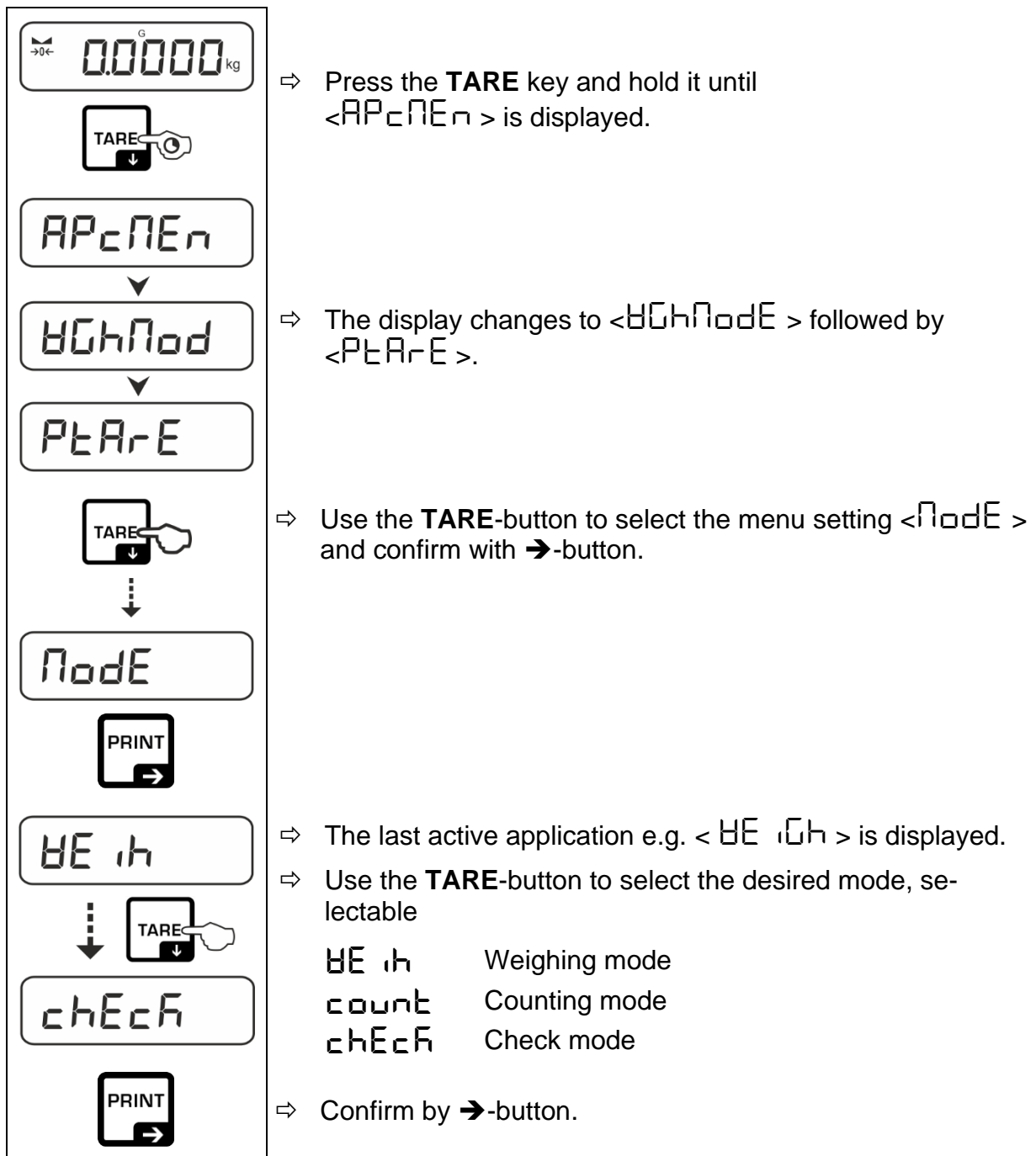

According to the selected application in the application menu just appear the application-specific settings, so that you reach the target quickly without deviation.



- Information about the application-specific settings you will find in the description of the respective application.
- All basic settings and parameters, which influence the whole operation of the balance, are resumed in the **Setup Menu** (see chap.14.3.). These settings remain valid for all applications.
- The number of the available applications depends on the model.

Change application:

- ⇒ Press the **TARE** button and keep it pressed until the first menu item of the setup menu will be displayed
- ⇒ Use the **TARE** -button to select the menu setting **< Mode >** and acknowledge with **→**-button. The current setting will be displayed.
- ⇒ Use the **TARE**-button to select the desired mode and acknowledge with **→**-button.

11 Application <Weighing >

How to carry out a simple weighing and taring, please refer to chap. 9.2 or 9.4. Further specific settings you will find in the following chapters.

i Shouldn't the application <Weighing> already be enabled, select the menu setting < **Mode** → **WEIGH** >, see chap. 14.1

11.1 Application-specific settings

Call up menu:

- ⇒ Press the **TARE** key and hold it until <**APPEL**> is displayed.
- ⇒ The display changes to <**WEIGH**> followed by <**PRE**>.
- ⇒ Navigation in menu see chap. 14.1

Overview (legal for trade models):

Level 1	Level 2	Description / Chapter	
PRE-TARE	ACTUAL	Take over the placed weight as PRE-TARE value, see chap. 11.2.1	
	NUMERICAL	Numerical input of the tare weight, see chap. 11.2.2.	
	CLEAR	Delete PRE-TARE value	
hold	-	Start-Hold function, see chap. 11.3	
units	g	This function defines in which weighing unit the result will be displayed. s. Kap. 11.4.1	
	kg		
	ct		
Application mode	WEIGH	Weighing mode	s. Kap. 14.2
	COUNT	Counting mode	
	CHECK	Check mode	

11.2 PRE-Tare

11.2.1 Taking over the placed weight as the PRE-TARE value

< P T A R E > → < A C T U A L >

	⇒	Place the scale container.
	⇒	Display the < P T A R E > menu setting and confirm, confirm by →-button.
	⇒	To take over the weight of the placed weight as PRE-TARE, use the navigation buttons ↓↑ to select < A C T U A L >.
	⇒	Confirm by →-button. < H A I T > will be displayed.
	⇒	The weight of the weighing container is stored as the tare weight. The zero indication and the indicators < P T A R E > and < N E T > appear
	⇒	Remove the weighing container, the following will be displayed: (NET) symbol and tare weight with a negative symbol.
	⇒	Place a filled weighing container.
	⇒	Wait until the stabilization indicator is displayed (▬).
	⇒	Read out the net weight.

i The entered tare value will be used until you enter a new one. To delete it, press TARE or confirm the menu item < C L E A R >, confirm by →-button.

11.2.2 Entering the known tare in the numerical form

<PTARE> → <NORMAL>

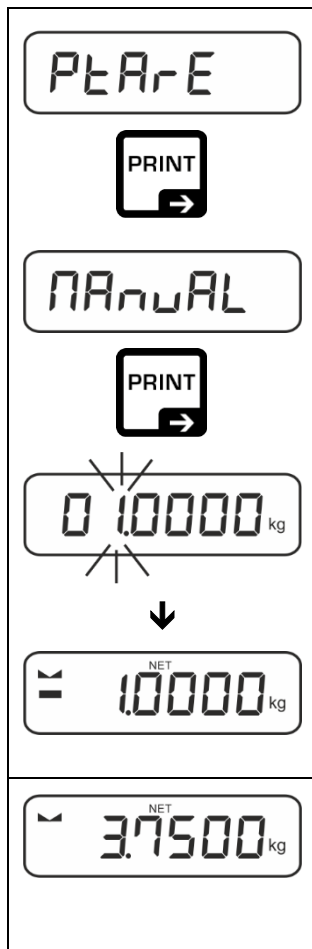

- ⇒ Display the <PTARE> menu setting and confirm, pressing →.
- ⇒ Use the navigation buttons ↓↑ to choose the setting <NORMAL> and confirm by →-button.
- ⇒ Enter the known tare value; for introducing the numerical value see chapter 0, the active item is blinking.
- ⇒ The entered weight will be saved as tare; <NET> and <PTARE> symbols will be shown and tare weight with a negative symbol will be displayed.
- ⇒ Place a filled weighing container.
- ⇒ Wait until the stabilization indicator is displayed (▴).
- ⇒ Read out the net weight.

i The entered tare value will be used until you enter a new one. To delete it, enter a zero value or confirm the menu item <CLEAR>, pressing →.

11.3 Data-hold function

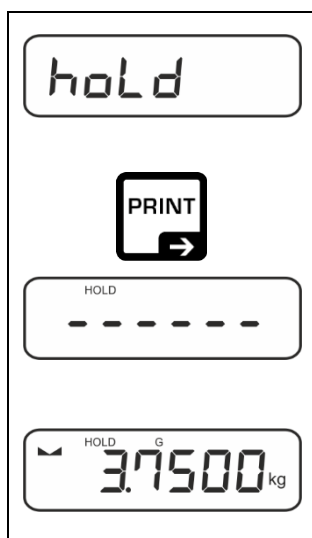

- ⇒ Choose the menu item <hold>.
- ⇒ Place the weighed material.
- ⇒ Confirm by →-button.
- ⇒ The first stable weight value is held symbolized by [HOLD] in the upper edge of the display. After unloading, the value is held in the display for another 10 s.

11.4 Unit

11.4.1 Switch-over weighing unit

By default, the Change button  is set to switch between the weighing unit by a **short** button press.

Activate units:

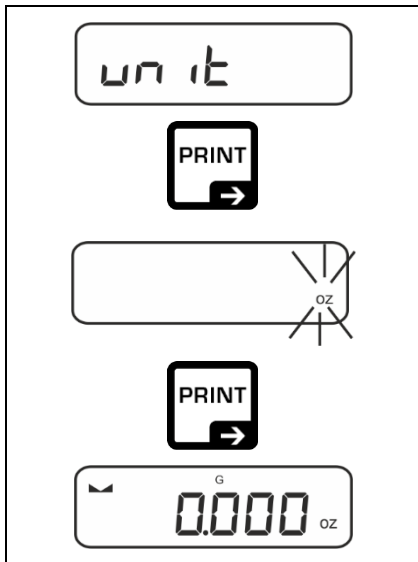

⇒ Select menu setting < unit > and confirm by →-button.

⇒ wait until the display flashes.

⇒ Use the navigation ↓↑ keys to select the and confirm by →-button.



- The required settings when selecting an application unit (FFA, %) can be found in chap. 11.4.3 and 11.4.2.
- The -key (default setting) can be used to switch between the active unit 1 and unit 2 (default setting of the keys, see Chap.9.5.1. Further setting options, see Chap.14.3.1).

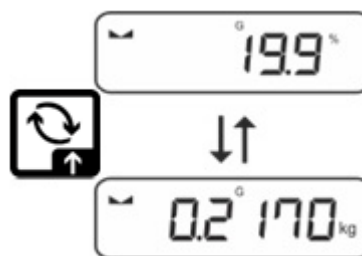

11.4.2 Weighing with the multiplication factor <FFA>

Here, you can specify the factor to be used for multiplying the weighing result (in grams).

All the same, determining weight you can consider e.g. the known error factor.

⇒ Select <unit> menu setting and confirm, confirm by →-button.

⇒ Use the navigation buttons ↓↑ to choose the setting <FFA> and confirm by →-button.

⇒ Enter the multiplication factor; for introducing the numerical value see chapter 11.4.2, the active item is blinking.

11.4.3 Percentage weighing <%>

<Percentage weighing> application enables to check the percentage sample weight in reference to the reference weight.

⇒ Choose the menu item <unit>.

⇒ Place the reference weight corresponding to 100%.

⇒ confirm by →-button.

⇒ Use the navigation buttons ↓↑ to choose the setting <%> and confirm by →-button.

⇒ Confirm the blinking weight value by pressing →-button.

⇒ From now on, the sample weight is displayed as percentage referring to the reference weight.

12 Application <Counting>



If the application <Counting> is not active yet, choose the menu item <MODE → count>, see chapter 9.5.

12.1 Settings specific for the application

Displaying the menu:

- ⇒ Press and hold the **TARE** button until the <APCERN> symbol is displayed.
- ⇒ The symbol is first changed to <count>, and then to <REF>.
- ⇒ Menu navigation, see chapter 14.1.

Overview:

Level 1	Level 2	Description/chapter	
REF Reference quantity	5	Number of reference items 5	
	10	Number of reference items 10	
	20	Number of reference items 20	
	50	Number of reference items 50	
	FREE	Selected arbitrarily; for introducing the numerical value see chapter 11.4.2	
	input	Input unit weight	
PRE-TARE PRE-TARE	ACTUAL	Taking over the placed weight as the PRE-TARE value, see chapter 11.2.1	
	MANUAL	Entering tare in the numerical form, see chapter 11.2.2	
	CLEAR	Deleting the PRE-TARE value	
TARGET Zielzahlen	VALUE	Target value	See chap. 12.2.1
	ERRUPP	Upper tolerance limit	
	ERRLOB	Lower tolerance limit	
	CLEAR	Delete settings	
MODE Applikationen	count	counting	See chap. 9.5
	check	Checkweighing	
	WEIH	weighing	







12.2 Apply application

Before it is possible to count pieces using the scale, you should determine the average weight of an individual part (unit weight), the so-called reference value. To do it, place the specific number of pieces which the counting the number of pieces will be carried out for. The scale will determine the total weight which will be divided by the number of pieces, the so-called reference piece number. Next, based on the calculated mean weight of an individual part, the number of pieces will be counted.

- i** • The higher number of the reference pieces, the higher the accuracy of counting the number of pieces.
- For small or highly diverse parts, the reference value must be sufficiently high.
- For the minimum weight of the counted pieces, see the “Technical specification” table.

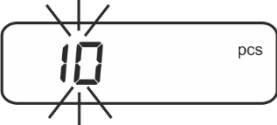
1. Setting the reference value

Number of reference items 5, 10, 20 or 50:

	⇒ Whenever required, place an empty container on the scale and tare it.
	⇒ Place the required number of reference items.
	⇒ Display the <rEF> menu setting and confirm by →-button.
	
	⇒ Using the navigation buttons ↓↑, select the number of reference items (5, 10, 20, 50) corresponding to the placed reference load and confirm by pressing →-button.
	
	⇒ The mean weight of an individual part will be determined by the scale and then the part number will be displayed.
	⇒ Remove the reference load. The scale is in the counting mode and counts all parts present on the scale plate.

Number of reference items defined by the user:

rEF	⇒ Whenever required, place an empty container on the scale and tare it.
PRINT →	⇒ Place the required number of reference items.
FrEE pcs	⇒ Display the <rEF> menu setting and confirm by →-button.
PRINT →	⇒ Use the navigation buttons ↓↑ to choose the setting <FrEE> and confirm by →-button.
000033 pcs	⇒ The window for value entry in the numerical form is displayed.
00033 pcs	⇒ Enter and confirm the number of reference parts placed; for introducing the numerical value see chapter 0.
↓	⇒ The mean weight of an individual part will be determined by the scale and then the part quantity will be displayed.
G 0 pcs	⇒ Remove the reference load. The scale is in the counting mode and counts all parts present on the scale plate.

Counting with freely selectable piece weight:

rEF	⇒ Select the <rEF> menu setting and confirm by →-button.
PRINT →	
inPut	⇒ Use the navigation buttons ↓↑ to choose the setting <inPut> and confirm by →-button.
PRINT →	
00034 kg	⇒ Use the navigation buttons ↓↑ to select the weighing unit and confirm by →-button.
3.4 g	⇒ Use the navigation buttons ↓↑ to select the position of the comma and confirm by →-button.

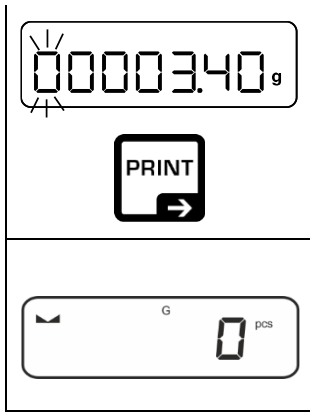

⇒ Enter unit weight, numerical input see chap 3.2.2, the active digit flashes.

⇒ confirm by →-button.

The scale is now in the piece counting mode and counts all pieces that are on the weighing plate.

2. Count parts

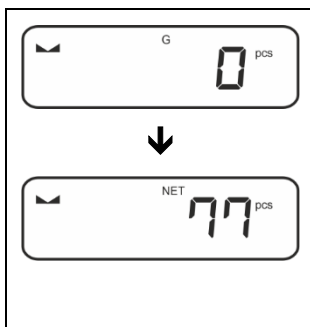

⇒ If necessary, place weighing container on and tare.

⇒ Fill in the counted quantity. The number of pieces is shown directly on the display.

i ↻-button enables to switch between the indication of the number of pieces and of the weight. (default setting see chap. 9.5).

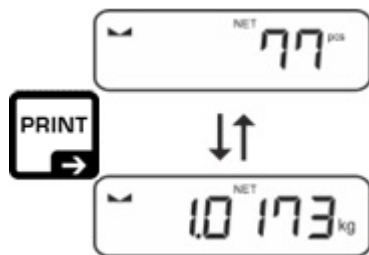



12.2.1 Check counting

The balance allows weighing of goods within set tolerances in keeping with a determined target quantity. With this function one can also check if the weighing good is within a defined tolerance range.

Reaching the target value is indicated by an acoustic (if activated in menu) and an optic signal (tolerance marks   ).

Visual signal:

The tolerance marks provide the following information:

	Target quantity exceeds defined tolerance
	Target quantity within defined tolerance
	Target quantity below defined tolerance

Acoustic signal:

The acoustic signal depends on the menu setting `< SETUP → BEEPER >`, see chap. 14.3.1.

Procedure:

1. Define target quantity and tolerances

	⇒ Make sure that the scale is in counting mode and that an average piece weight has been defined (see chap. 12.2). If necessary, switch over with the key.
	⇒ Use the navigation keys to select the setting < TARGET > and confirm by -button.
	< VALUE > is displayed.
	⇒ Enter the target number of pieces (numerical input see chap.3.2.2) and confirm the entry.
	The balance returns to the < VALUE > menu.
	⇒ Use the navigation keys to select the setting < ERRUPP > and confirm by button.
	⇒ Use the navigation keys to select the weighing unit and confirm by button.
	⇒ The numeric input window appears. The active digit is flashing.
	⇒ Enter the upper tolerance (for numerical entry see chap.3.2.2) and confirm the entry.
	The balance returns to the < ERRUPP > menu.

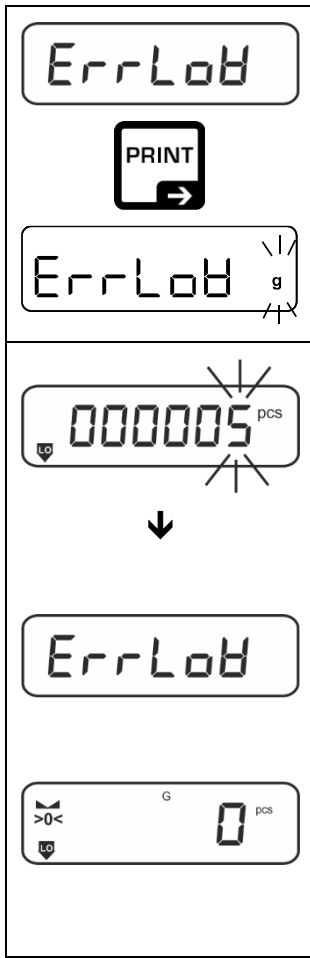

⇒ Use the navigation keys ↓↑ to select the setting <ErrLob> and confirm with → button.

⇒ Use the navigation keys ↓↑ to select the weighing unit and confirm by → button.

⇒ The numeric input window appears. The active digit is flashing.

⇒ Enter the upper tolerance (for numerical entry see chap.3.2.2) and confirm the entry.

The balance returns to the <ErrLob> menu.

⇒ Press repeatedly ←-button to exit menu.

Finished the setting works, the weighing balance will be ready for check counting.

2. Start tolerance check:

⇒ Determine the average item weight, see chap. 13.2.1

⇒ Place the weighed material and check by means of the tolerance marks / acoustic signal if the weighed material is within the defined tolerance.

Load below specified tolerance	Load within specified tolerance	Load exceeds specified tolerance



The entered values are valid until new values are entered.

To clear the values, select menu setting <TARGET> → <CLEAR> and confirm by →-button.

13 Application < Checkweighing >

i If the application <Weighing with the tolerance range> is not active yet, choose the menu item <MODE → CHECK>, see chapter 9.5

13.1 Settings specific for the application

Displaying the menu:

- ⇒ Press and hold the **TARE** button until the <APCERN> symbol is displayed.
- ⇒ The symbol is first changed to <CHFNOD>, and then to <TAREET>.
- ⇒ Menu navigation, see chapter 14.1.

Overview:

Level 1	Level 2	Description/chapter
TAREET Target weighing, see chapter 13.2.1	VALUE	Target weight, numerical value see chapter 3.2.2
	ERRUPP	Upper tolerance limit, numerical value see chapter 3.2.2
	ERRLOB	Lower tolerance limit, numerical value see chapter 3.2.2
	CLEAR	Delete setting
L N LB Checkweighing, see chapter 13.2.2	L NUPP	Upper limit value, for entering the numerical value see chapter 3.2.2
	L NLOB	Lower limit value, for entering the numerical value see chapter 3.2.2
	CLEAR	Delete setting
PREARE PRE-TARE	ACTUAL	Taking over the placed weight as the PRE-TARE value, see chapter 11.2.1
	MANUAL	Entering tare in the numerical form, see chapter 11.2.2
	CLEAR	Deleting the PRE-TARE value
MODE Applicationen mode	WE ih	weighing mode
	COUNT	counting mode
	CHECK	check mode
		see chapter 10

13.2 Apply application



13.2.1 Target weighing

The balance allows weighing of goods within set tolerances in keeping with a determined target quantity. With this function one can also check if the weighing good is within a defined tolerance range.

Reaching the target value is indicated by an acoustic (if activated in menu) and an optic signal (tolerance marks ).

Visual signal:

The tolerance marks provide the following information:

	Upper limit
	Target weight
	Lower limit

Acoustic signal:

The acoustic signal depends on the menu setting `< SETUP → BEEPER >`, see chap. 14.3.1.

Procedure:

1. Defining the target weight and tolerance

⇒ Use the navigation buttons $\uparrow\downarrow$ to choose the setting <TARGET> and confirm by \rightarrow -button.

<VALUE> will be displayed.

⇒ Confirm by \rightarrow -button, the numerical value entry box is displayed. The active item is blinking.

⇒ Enter the target value (for entering the numerical value see chapter 0) and confirm.

The scale will be switched to the menu <VALUE> again.

⇒ Using the navigation buttons $\uparrow\downarrow$, select the <ERRUPP> setting and confirm by \rightarrow -button.

⇒ Use the navigation keys $\downarrow\uparrow$ to select the weighing unit and confirm by \rightarrow button.

⇒ The numeric input window appears. The active digit is flashing.

⇒ Enter the upper tolerance (for numerical entry see chap.3.2.2) and confirm the entry.

⇒ The balance returns to the <ERRUPP> menu.

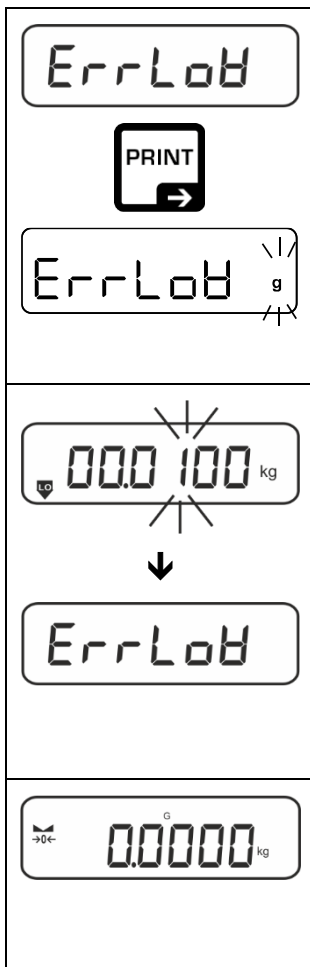

⇒ Using the navigation buttons \uparrow/\downarrow , select the <ErrLoB> setting and confirm by \rightarrow -button.

⇒ Use the navigation keys \downarrow/\uparrow to select the weighing unit and confirm by \rightarrow -button.

⇒ The numeric input window appears. The active digit is flashing.

⇒ Enter the upper tolerance (for numerical entry see chap.3.2.2) and confirm the entry.

⇒ The balance returns to the <ErrLoB> menu.

⇒ Press repeatedly \leftarrow -button to exit menu.

Finished the setting works, the weighing balance will be ready for check counting.

3. Start tolerance check:

⇒ Place the weighed material and check by means of the tolerance marks / acoustic signal if the weighed material is within the defined tolerance.

Load below specified tolerance	Load within specified tolerance	Load exceeds specified tolerance



The entered values are valid until new values are entered.

To clear the values, select menu setting <TARGET> \rightarrow <CLEAR> and confirm with \rightarrow key.



13.2.2 Checkweighing

The application <**Checkweighing**> enables to check if the weighed material belongs to the preset tolerance range.

Exceeding the limit values (fall below and rise above) is signaled with a visual indication (tolerance symbols) and an audible indication (if enabled in the menu).

Visual signal:

Tolerance symbols provide the following information:

	Weighed material above the preset tolerance,
	Weighed material in the preset tolerance range
	Weighed portion below the preset tolerance,

Acoustic signal:

The acoustic signal depends on the menu setting <SEtUP → bEEPER >, see chap. 14.3.1

Procedure:

1. Grenzwerte definieren

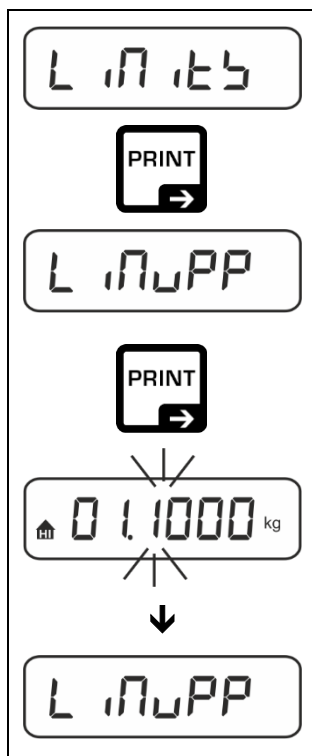

⇒ Use the navigation buttons ↓↑ to choose the setting <L 17.15> and confirm by pressing →.

The <L 17.00> symbol will be displayed.

⇒ Confirm by →-button. The window for value entry in the numerical form will be displayed where you can enter the upper limit value. The active item is blinking.

⇒ Enter the upper limit value (for entering the numerical value see chapter 3.2.2) and confirm.

The scale will be switched to the menu <L 17.00> again.

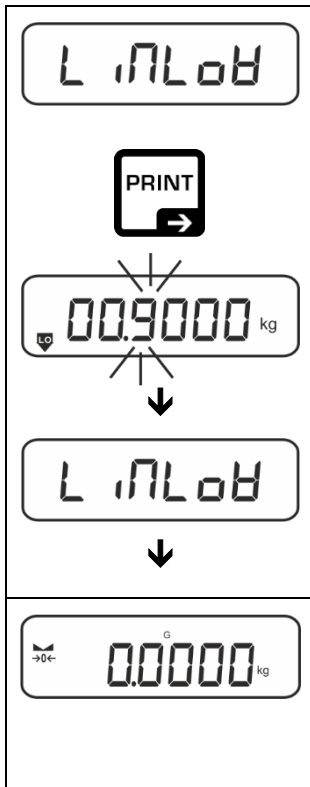

- ⇒ Using the navigation buttons $\downarrow\uparrow$, select the $\langle L \text{ nLoB} \rangle$ setting.
 - ⇒ Confirm by \rightarrow -button. The window for value entry in the numerical form will be displayed where you can enter the lower limit value. The active item is blinking.
 - ⇒ Enter the lower limit value (for entering the numerical value see chapter 3.2.2) and confirm.
- The scale will be switched to the menu $\langle L \text{ nLoB} \rangle$ again.
- ⇒ To leave the menu, press \leftarrow several times.
 - ⇒ Once the setting works are completed, the scale is ready to start checkweighing.

2. Start tolerance check:

- ⇒ Place the weighing material and based on the tolerance marks / acoustic signal, check if the weighed material belongs to the preset tolerance range.

Weighed material below the preset tolerance	Weighed material in the preset tolerance range	Weighed material above the preset tolerance



The entered values are valid until new values are entered.

To clear the values, select menu setting $\langle L \text{ nLoB} \rangle \rightarrow \langle \text{CLEAR} \rangle$ and confirm with \rightarrow key.

14 Menu

14.1 Menu navigation

Displaying the menu:

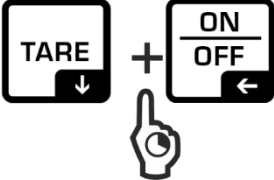
Application menu	Setup menu
 <p>In the weighing mode press and hold TARE button until the first menu item is displayed.</p>	 <p>Press and hold TARE i ON/OFF buttons simultaneously until the first menu item is displayed.</p>

Parameter choice and setting:

<p>Scrolling on the sale level</p>	<p>Using the navigation buttons, you may select consecutive menu blocks.</p> <p>Scroll forward using the navigation button ↓.</p> <p>Scroll backward using the navigation button ↑.</p>
<p>Activating menu item / selection confirmation</p>	<p>Press the navigation button →.</p>
<p>Return to a higher menu level / return to the weighing mode</p>	<p>Press the navigation button ←.</p>

14.2 Application menu

The application menu enables fast and targeted access to the selected application (see chapter 9.5).



The overview of specific application settings is provided in every application description.

14.3 Setup-menu

The setup menu enables to adapt the scale settings / scales behavior to your requirements (e.g. ambient conditions, special weighing processes).

Such settings are general and independent of the selected application. (except: <buttlon>).

14.3.1 Overview <SETUP>

Level 1	Level 2	Description/chapter	
cAL calibration	cAL int	→ Internal calibration, see chap. 7.9.1	
	cALt int	→ Define calibration interval see chap. 7.9.2	
	cALGLP	→ GLP compliant calibration protocol see chap.7.9.3	
com Kommunikation	rs232 ↓ usb-d	baud	600
			1200
			2400
			4800
			9600
			14400
			19200
			38400
			57600
			115200
			128000
		256000	
		data	7db it
			8db it
		PAR it	nonE
odd			
EUEn			
stop	1sb it		
	2sb it		
handsh	nonE		
Protoc	rcP		

Print Data transmission	interface		rs232	RS-232 interface*				
			usb-d	USB interface* * Only in connection with KUP interface				
			wlan	WiFi-interface* * Only in connection with KUP interface				
	sum		on	Summing mode on/off, see chapter 15.3.1				
			off					
	Print mode	trigger	MANUAL	on, off Data transfer after pressing the PRINT button, see chapter 15.3.2				
			AutoPr	on, off Automatic data sending with the stable and positive weighing value, see chapter 15.3.3. Displaying again only when the zero indication is displayed and stabilized, depending on <Z RANGE> settings, you can choose: (off, 1, 2, 3, 4, 5) . <Z RANGE > defines a factor for d. This factor multiplied by d gives the threshold above which a value is no longer considered stable.				
			cont	off	Continuous data transfer			
				on	PstAb	preset cycle see chap. 15.3.4		
					PZero	on, off 0 (unloaded) also send continuously		
			weight	GLPrt	GLPrt	on, off Indicated weight value is transmitted		
					GntPrt	Grob	on, off	
				net		on, off		
				tArE		on, off		
				ForNA		Long (Extended measurement protocol) Short (Standard measurement protocol)		
	Layout	none		on, off Standard-Layout				
		user	Model	on, off Model name will be transmitted				
			Serial	on, off Serial number will be transmitted				
			AL id	Alibi-ID output				
			date	Date output				
time			Time output					
GLP		on, off GLP compliant weighing protocol output						
reset	no	Do not delete settings						
	yes	Delete settings						

bEEPEr Acoustic signal	REYb	oFF	acoustic signal switch on/off by pressing the button		
		on			
	chEcH	ch-oh	oFF	The acoustic signal is off	
			bLoB	Slow	
			bEd	Standard	
			FASt	Fast	
			cont.	Continuous	
		ch-Lo	oFF	The acoustic signal is off	
			bLoB	Slow	
			bEd	Standard	
			FASt	Fast	
			cont.	Continuous	
		ch-hi	oFF	The acoustic signal is off	
			bLoB	Slow	
	bEd		Standard		
FASt	Fast				
cont.	Continuous				
AutoFF Automatic switch-off function in battery mode	NoDE	oFF	Automatic switch-off function enabled		
		Auto	Automatic scale switch-off after the time defined in <t iNE> menu item elapsed with no change of the load or when not operated		
		onLY0	Automatic switch-off only for the zero indication		
	t iNE	30b	Automatic scale switch-off after the preset time elapsed with no change of the load or when not operated		
		1n in			
		2n in			
		5n in			
		30n in			
			60n in		

button Button assignment	change	5Push ↓ 1Push	default	Default setting, see chap. 9.5
			off	Deactivate key
			cal int	Activate internal calibration, 7.9.1
			unit	Set weighing unit, see chap. 11.4.1
			mode	Select weighing application, see chap. 10
			hold	Perform HOLD function, see chap. 11.3
			pre-tare	Open PRE-Tare settings, see chap. 11.2
			ref	Set reference quantity, see chap. 12.1 * only for the <count> application
			limits	Open settings for checkweighing, see chap.13.2.2 * only for the <checkweighing> application
			target	Open settings for target weighing, see chap. 13.2.1 * only for the <checkweighing> application
blight Display backlight	mode	always	Backlight of the display permanently switched on	
		timer	The backlight is automatically switched off after the time defined in the menu item < timer > without load change or operation.	
		no bl	Backlight of the display permanently switched off	
	timer	5s	Definition, after which time without load change or operation the backlight is automatically switched off.	
		10s		
		30s		
		1min		
		2min		
		5min		
	30min			

ታሪክ Date and time	ሪታይ	-2022- 12-31 23.59.59	Enter date & time
	ታሪክ ፎርማት	DD; DD; YD	Select date format
	ሪታይ ፎርማት	12h; 24h	Select time format
ህግ ስርዓት units	available weighing units / application units, see chap. 1	ON, OFF This function is used to define which weighing units are available in the application-specific <ህግ ስርዓት> menu. The units set to <ON> are available in the application-specific menu.	
ግብይት applications	ዘይት	Weighing mode	
	ቀንቀን	Counting mode	
	ቅጥር	Checkweighing mode	
ሊክ	ሪታይሊክ	ON, OFF This function can be used to block access to the setup menu. When set to <ON>, the entry of a 6-digit number is required as a password.	
ሪሪታይት	Resetting the balance settings to factory defaults		

15 Communication with a peripheral device using KUP

Via the interfaces, weighing data can be exchanged with connected peripheral devices.

The output can be made to a printer, PC or control displays. Conversely, control commands and data inputs can be made via the connected devices.

The scales are equipped with a KUP connection (KERN Universal Port) as standard.



KUP-interface

All available KUP interface adapters can be found in our webshop at:

<http://www.kern-sohn.com>

15.1 KERN Communications Protocol

KCP is a standardized set of interface commands for KERN scales enabling to display many parameters and functions of the device and to control them. Thanks to it, KERN devices with KCP may be easily connected to a computer, industrial control systems and other digital systems. The detailed description can be found in the *KERN Communication Protocol* manual, available in the Downloads tab on the home page of KERN (www.kern-sohn.com).

To activate KCP, follow the description in the menu overview in the manual for a given scale.

KCP is based on ordinary commands and responses in ASCII format. Every interaction is composed of a command or arguments separated by spaces and is finished with <CR>< LF> commands.

KCP commands supported by the scale may be displayed by sending an inquiry composed of "I0" command and CR LF commands.

The list of most often use KCP commands:

I0	Display all the implemented KCP commands
S	Submit a stable value
SI	Submit the current value (including an unstable one)
SIR	Submit the current value (including an unstable one) and repeat
T	Taring
Z	Zeroing

Example:

Befehl	S	
Possible responses	S_ S_.....100.00_g S_ S_+ or S_-	Command acceptance, command implementation start Another command is implemented now, time limit exceeded Overloading or insufficient loading

15.2 KERN alibi memory

For weighings where verification is mandatory and which are to be analysed and processed by a PC (e.g. printing out a packing list using a PC instead of a printer connected directly to the balance) electronic archiving is required by the metrological authorities by a verifiable data memory which cannot be manipulated. These stored data strings can be retrieved & displayed at any time via a connected PC

- The Alibi memory offers the possibility to store up to 250.000 weighing results, when the memory is exhausted, already used IDs are overwritten (starting with the first ID).
- By pressing the Print key or by KCP remote control command "S" or "MEMPRT" the storage process can be performed.
- The weight value (N, G, T), date and time and a unique alibi ID are stored.
- When using a print option, the unique alibi ID is also printed for identification purposes as well.
- The stored data can be retrieved via the KCP command "MEMQID". This can be used to query a specific single ID or a series of IDs.
- Example:
 - o MEMQID 15 → The data record which is stored under ID 15 is returned.
 - o MEMQID 15 20 → All data sets, which are stored from ID 15 to ID 20, are returned.

The detailed description can be found in the *KERN Communication Protocol* manual, available in the Downloads tab on the home page of KERN (www.kern-sohn.com).

i	<ul style="list-style-type: none">- Protection of stored legally relevant data:<ul style="list-style-type: none">o After a record is stored, it will be read back immediately and be verified byte by byte. If error is found that record will be marked as an invalid record. If no error, then the record can be printed if needed.o There is checksum protection stored in every record.o All information on a printout is read from the memory with checksum verification, instead of direct from buffer. - Data loss prevention measures:<ul style="list-style-type: none">o The memory is write-disabled upon power-up.o A write enable procedure is performed before writing a record to the memory.o After a record is stored, a write disable procedure will be performed immediately (before verification).o The memory has a data retention period longer than 20 years.
----------	---

15.3 Data transfer functions

15.3.1 Summing mode <Σ>

This function enables to add individual weighing values to the total memory once the button is pressed and to print them once connected to an optional printer.

Function enabling:

- ⇒ In the setup menu, display the <Pr Mode → Σ> menu item and confirm, pressing →.
- ⇒ Use the navigation buttons ↓↑ to choose the setting <ON> and confirm by pressing →.
- ⇒ To leave the menu, press the navigation button ← several times.



Preliminary condition: Menu setting <Pr Mode → Tr G → MANUAL → ON>

Summing the weighed material:

- ⇒ Whenever required, place an empty container on the scale and tare it.
- ⇒ Place the first weighed material. Wait until the stabilization indicator is displayed (▲▲), and press PRINT. First <Σ 1> symbol and then the current weight value will be displayed. The weight value will be saved and sent to the printer. The Σ symbol will be displayed. Remove the weighed material.
- ⇒ Place the second weighed material. Wait until the stabilization indicator is displayed (▲▲), and press PRINT. First <Σ 2> symbol and then the current weight value will be displayed. The weight value will be saved and sent to the printer. Remove the weighed material.
- ⇒ Add the weight of another weighed material to the total, as specified above.
- ⇒ This process may be repeated at any frequency until you reach the scale weighing range.

Displaying and printing the “Total”

- ⇒ Press and hold the PRINT button. The number of weighing actions and the total weight will be displayed.
The total memory will be deleted; the [Σ] symbol will go off.

Protocol template (KERN YKB-01N)

Menu setting

<PrNode → ForNAt → Short>

No.			1		First weighing
N:	S S	1.9993 kg			
T:		0.0000 kg			
G:		1.9993 kg			
C:		1.9993 kg			
No.			2		Second weighing
N:	S S	0.9992 kg			
T:		0.0000 kg			
G:		0.9992 kg			
C:		2.9985 kg			
No.			3		Third weighing
N:	S S	0.4992 kg			
T:		0.0000 kg			
G:		0.4992 kg			
C:		3.4977 kg			
No.			3		Number of weighing actions /total
C:		3.4977 kg			

Protocol template (KERN YKB-01N)

Menu setting

<PrNode> → <BE iGht> → <SGLPrt> → <on>

No.			1		First weighing
C:	200.0 g	200.0 g			
No.			2		Second weighing
C:	500.0 g	700.0 g			
No.			3		Third weighing
C:	400.0 g	1100.0 g			
No.			4		Fourth Weighing
C:	100.4 g	1200.4 g			
No.			4		Number of weighing actions /total
C:		1200.4 g			

15.3.2 Data transfer after pressing the PRINT <PRINT> button

Function enabling:

- ⇒ In the setup menu, display the <Print → PrintMode> → <Print> menu item and confirm, pressing →.
- ⇒ To transfer data manually, using navigation buttons ↑, choose the <PRINT> menu item and confirm by pressing →.
- ⇒ Use the navigation buttons ↑ to choose the setting <ON> and confirm by pressing →.
- ⇒ To leave the menu, press the navigation button ← several times.

Placing the weighed material:

- ⇒ Whenever required, place an empty container on the scale and tare it.
- ⇒ Place the weighed material. The weighing value will be transferred after PRINT button is pressed.

15.3.3 Automatic data transfer <AUTO>

Data transfer takes place automatically without pressing the **PRINT** button provided the appropriate transfer conditions are met depending on the menu setting.

Function enabling and transfer condition setting:

- ⇒ In the setup menu, display the <PRINT → MODE → <ENTER> menu item and confirm, pressing →.
- ⇒ To transfer data automatically, using navigation buttons ↓↑, choose the <AUTO> menu item and confirm by pressing →.
- ⇒ Use the navigation buttons ↓↑ to choose the setting <ON> and confirm by pressing →. The <ON OFF> symbol will be displayed.
- ⇒ Confirm by pressing → and use the navigation settings ↓↑ to set the required transfer condition.
- ⇒ Confirm pressing →.
- ⇒ To leave the menu, press the navigation button ← several times.

Placing the weighed material:

- ⇒ Whenever required, place an empty container on the scale and tare it.
- ⇒ Place the weighed material and wait until the stabilization indicator is displayed ().
The weighing value will be transferred automatically.

15.3.4 Continuous data transfer <CONT>

Function enabling and transfer cycle setting:

- ⇒ In the setup menu, display the <PRINT → MODE → <ENTER> menu item and confirm, pressing →.
- ⇒ To transfer data continuously, using navigation buttons ↓↑, choose the <CONT> menu item and confirm by pressing →.
- ⇒ Use the navigation buttons ↓↑ to choose the setting <ON> and confirm by pressing →.
- ⇒ The <ON OFF> symbol will be displayed.
- ⇒ Confirm by pressing → and using the navigation buttons, ↓↑, set the required cycle (for introducing the numerical value, see chapter 0).
- ⇒ To leave the menu, press the navigation button ← several times.

Place the weighed material.

- ⇒ Whenever required, place an empty container on the scale and tare it.
- ⇒ Place the weighed material.
- ⇒ The weighing values will be transferred in line with the predefined cycle.

15.4 Data format

- ⇒ In the setup menu, display the <Pr int → PrNode → BEight → UnitPrnt > menu item and confirm, pressing →.
- ⇒ Use the navigation buttons ↑ to choose the menu setting <FoRmAt> and confirm by pressing →.
- ⇒ Using the navigation buttons ↑, select the required setting. You can choose:
 - <Short> Standard measurement protocol
 - <Long> Extended measurement protocol
- ⇒ Confirm the setting, pressing →.
- ⇒ To leave the menu, press the navigation button ← several times.

Protocol template (KERN YKB-01N)

FoRmAt → Short		FoRmAt → Long	
N:	SS	2.0000 kg	
T:		0.5000 kg	
G:		2.5000 kg	
N:		SD	2.0000 kg
		Tara weight after x:	0.5000 kg
		Gross weight:	2.5000 kg

16 Maintenance, service and disposal



Before you start any works related to the maintenance, cleaning and repair, disconnect the device from the operating voltage.

16.1 Cleaning

Do not use any aggressive cleaning agents (solvents etc.), but clean the device with a cloth and mild soap solution. The liquid must not get inside the device. Wipe with a dry, soft cloth.

Any loose specimen/powder remains can be removed carefully with a brush or a handheld vacuum cleaner.

Remove any scattered weighed material immediately.

16.2 Maintenance and service

- ⇒ The device can be operated and maintained solely by the technicians trained and authorized by KERN.
- ⇒ Disconnect from the mains before opening.

16.3 Disposal

The packaging and the device should be disposed in accordance with the national or regional law in the location where the device is operated.

17 Help for any minor failures

If there are any program execution problems, the scale should be switched off and disconnected from the mains for a while. Next, the weighing process should be started anew.

Problem	Possible cause
The weight indicator is not lit	<ul style="list-style-type: none">• The scale is not on.• Interrupted mains connection (mains cable not connected/damaged).• Mains voltage failure.
The weight indication keeps fluctuating.	<ul style="list-style-type: none">• Draft / air movements.• Table/air vibrations.• The scale plate is in contact with foreign bodies.• Electromagnetic fields / static discharge (select another location / if possible, switch off the interfering device).
The weighing result is clearly wrong.	<ul style="list-style-type: none">• The scale indication was not reset.• Incorrect adjustment.• Scale not placed on a level surface.• There are heavy temperature fluctuations.• The heating time not observed.• Electromagnetic fields / static discharge (select another location / if possible, switch off the interfering device).

18 Error messages

Error message	Explanation
0L n t	Zeroing range exceeded (upward)
undEr0	Zeroing range exceeded (downward)
inStAb	Unstable load
ErOnG	Adjustment error
5Et r t c	Date & time not correct or not set
n unAU	Alibi memory not available or not working
no 232	RS 232-KUP not available for printing
no BLAn	WiFi-KUP not available for printing
L _ _ _ J	Insufficient loading
Γ _ _ _ 7	Overloading
Lo bAt	Discharged batteries/rechargeable batteries